

# CARTER

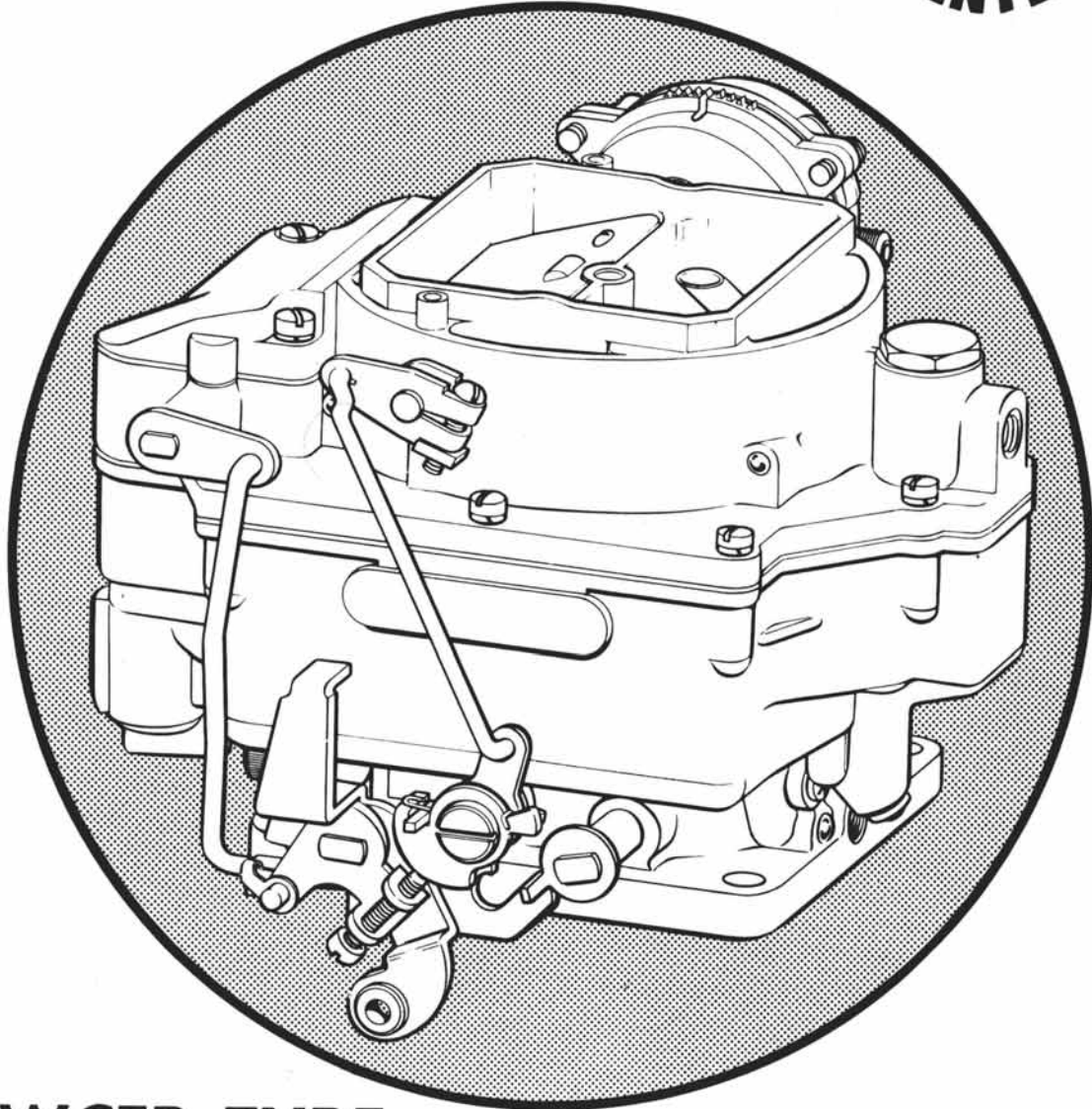

**WCFB TYPE**

# CARBURETOR

CARTER CARBURETOR CORPORATION, ST. LOUIS, MO., U. S. A.

***Explanation of Circuits***  
**Carter WCFB Four-Barrel Climatic  
Control Carbureter**

The Carter Model WCFB carbureter is basically two (2) Dual carbureters contained in one assembly. The section containing the metering rods, accelerating pump and choke is termed the primary side of the carbureter, the other section, the secondary side. It has five (5) conventional circuits, as have been used in previous carbureters. They are:

- 2 - Float Circuits
- 2 - Low Speed Circuits
- 2 - High Speed Circuits
- 1 - Pump Circuit
- 1 - Climatic Control (choke) Circuit

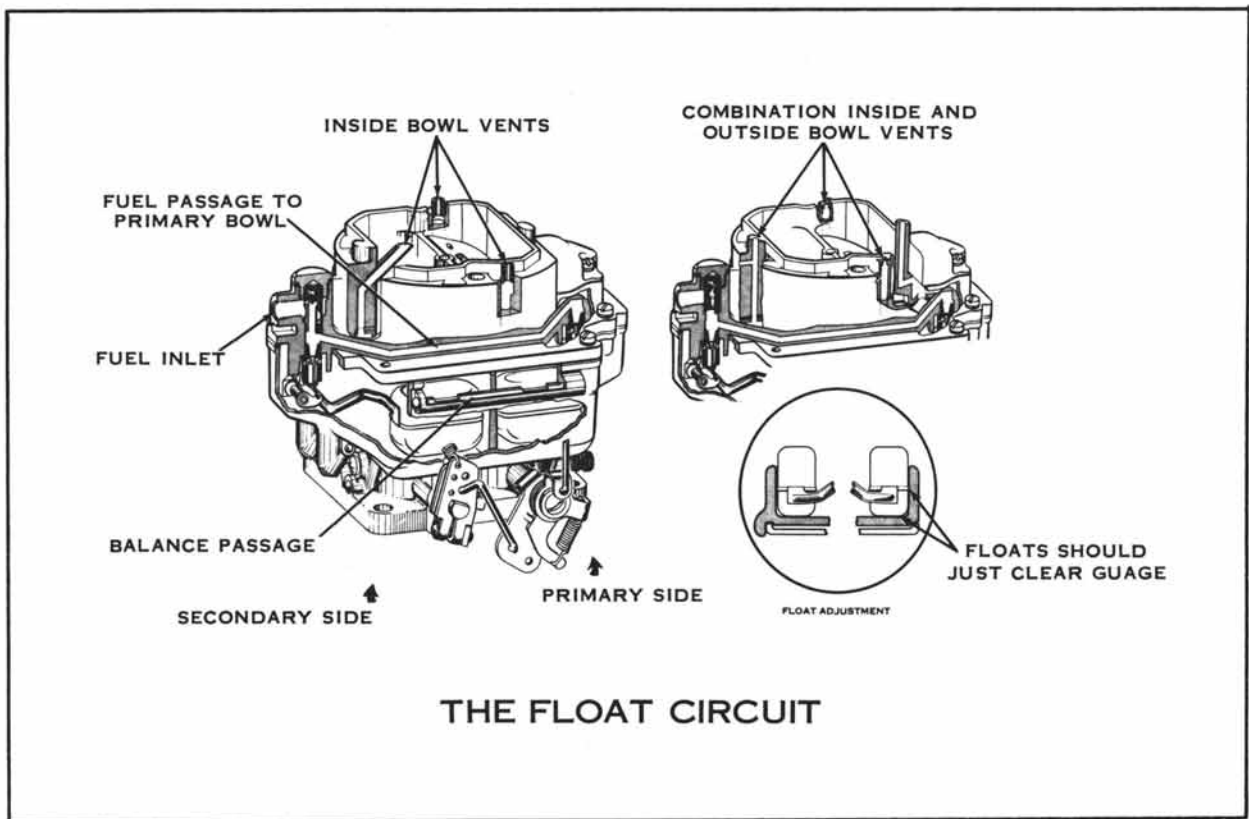

## FLOAT CIRCUITS

The purpose of the float circuits is to maintain an adequate supply of fuel at the proper level in the bowls for use by the low-speed, high-speed, pump and choke circuits. Primary and secondary bowls are separated by a partition. The fuel line connection is above the secondary needle and seat. Fuel is supplied to the primary needle and seat through the passage in the bowl cover.

Setting the floats to specifications assures an adequate supply of fuel in the bowls for all operating conditions. Float adjustments must be made with the bowl cover gasket removed and should be checked vertically (specified distance between bowl cover and bottom of floats) and laterally (sides of floats should just clear the arms of gauge). Correct lateral adjustment is important. If the floats are misaligned, they may bind or drag against

the inner walls of the bowl. Adjust by bending the float arms.

Intake needles and seats are carefully matched during manufacture. Do not use the primary needle in the secondary seat or vice versa. To avoid unnecessary bending, both floats should be reinstalled in their original positions and then adjusted.

The bowls are vented to the inside of the air horn and on certain models also to atmosphere. Bowl vents are calibrated to provide proper air pressure above the fuel at all times. To assure a positive seal, always use a new bowl cover gasket when reassembling. An air leak at this point can result in a mileage complaint.

A connecting passage along the outside of the body effects a balance of the fuel levels and air pressures between the two bowls.

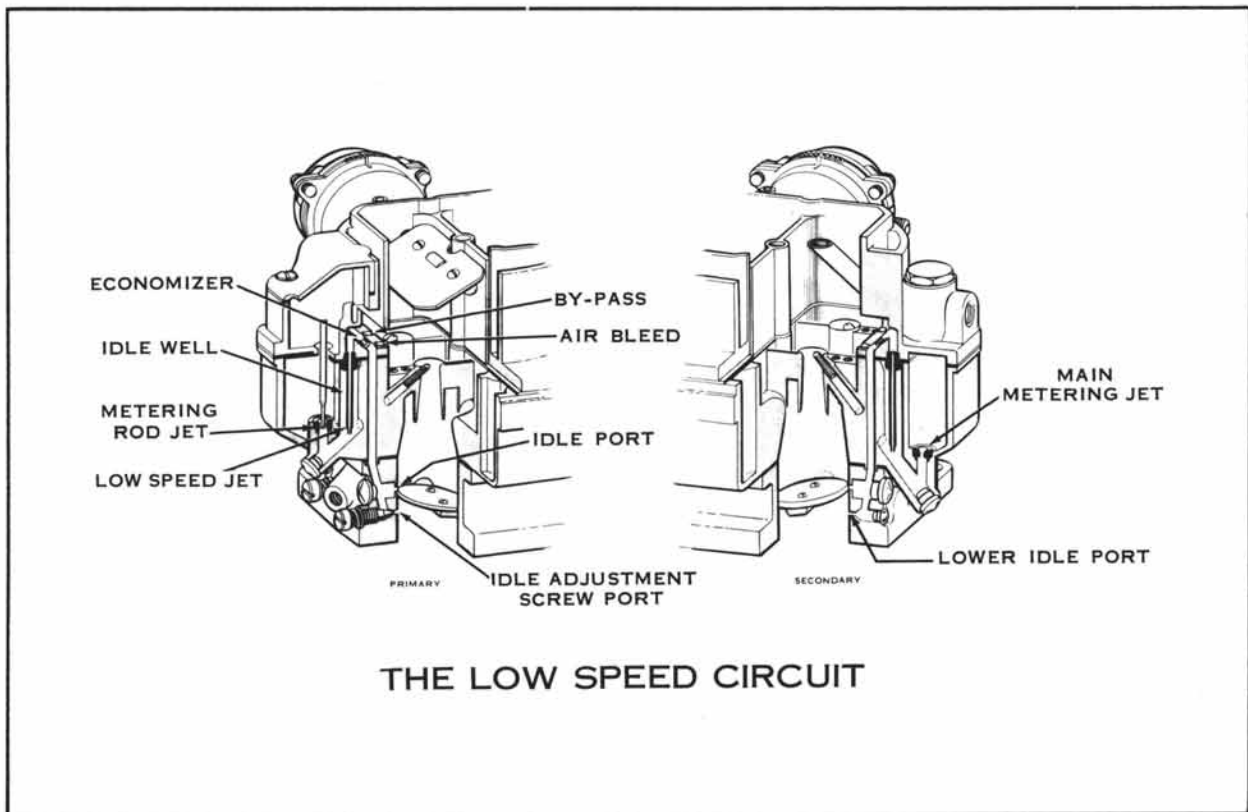

## LOW SPEED CIRCUITS

Fuel for idle and early part throttle operation is metered through the low speed circuits.

Gasoline enters the idle wells through the metering rod jets on the primary side of the carbureter and through the main metering jets on the secondary side.

The low speed jets measure the amount of fuel for idle and early part throttle operation. The air by-pass passages, economizers and idle air bleeds are carefully calibrated and serve to break up the liquid fuel and mix it with air as it moves through the passages to the idle ports and idle adjustment screw ports. Turning the idle adjustment screws toward their seats reduces the quantity of fuel mixture supplied by the idle circuit. There are no idle adjustment screws on the secondary side of the carbure-

ter.

The idle ports are slot shaped. As the throttle valves are opened more of the idle ports are uncovered allowing a greater quantity of the gasoline and air mixture to enter the carbureter bores. The secondary throttle valves remain seated at idle.

The vapor vent ball check operated by the arm on the countershaft provides a vent for fuel vapors to escape from the carbureter bowls to the outside at idle and when the engine is not in operation.

All by-passes, economizers, idle ports, idle adjustment screw ports, as well as the bore of the carbureter flange must be clean and free of carbon. Obstructions will cause poor low speed engine operation. Worn or damaged idle adjustment screws or low speed jets should be replaced.

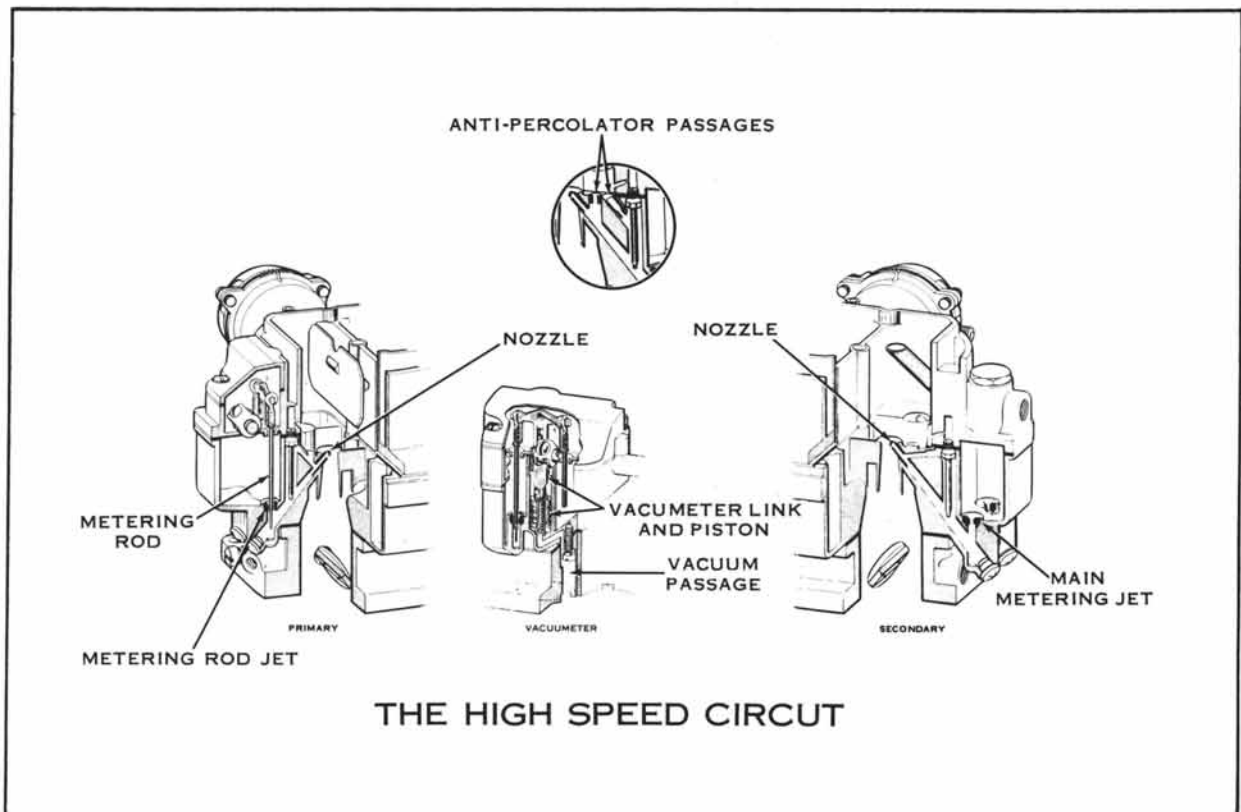

## HIGH SPEED CIRCUITS

Fuel for part throttle and full throttle operation is supplied through the high speed circuits.

### PRIMARY SIDE

The position of the metering rods in the metering rod jets controls the amount of fuel flowing in the high speed circuit of the primary side of the carburetor. The position of the metering rods is dual controlled, mechanically by movement of the throttle and by manifold vacuum applied to the vacuum piston on the vacuumeter link.

### SECONDARY SIDE

Fuel for the high-speed circuit of the secondary side is metered at the main metering jets (no metering rods used).

Throttle valves in the secondary side remain closed until the primary throttle valves have been opened a pre-determined amount. They arrive at wide open throttle position at the same time the primary throttle does. This is accomplished by linkage between the throttle levers. Certain models have offset throttle valves mounted above the secondary throttle valves, these are called "auxiliary

throttle valves". Air velocity through the carburetor controls the position of the auxiliary throttle valves. When the accelerator is fully depressed, only the primary high-speed circuit will function until there is sufficient air velocity to open the auxiliary throttle valves. When this occurs, fuel will also be supplied through the secondary high-speed circuit.

Auxiliary throttle valves or the secondary throttle valves on models without auxiliary valves, are locked closed during choke operation to insure faster cold engine starting.

### ANTI-PERCOLATOR

To prevent the vapor bubbles in the nozzle passages and low-speed wells caused by heat from forcing fuel out of the nozzles, anti-percolator passages, and calibrated plugs or bushings are used. Their purpose is to vent the vapors and relieve the pressure before it is sufficient to push the fuel out of the nozzles and into the intake manifold. Anti-percolator plugs, bushings, and main nozzles are permanently installed and must not be removed in service.

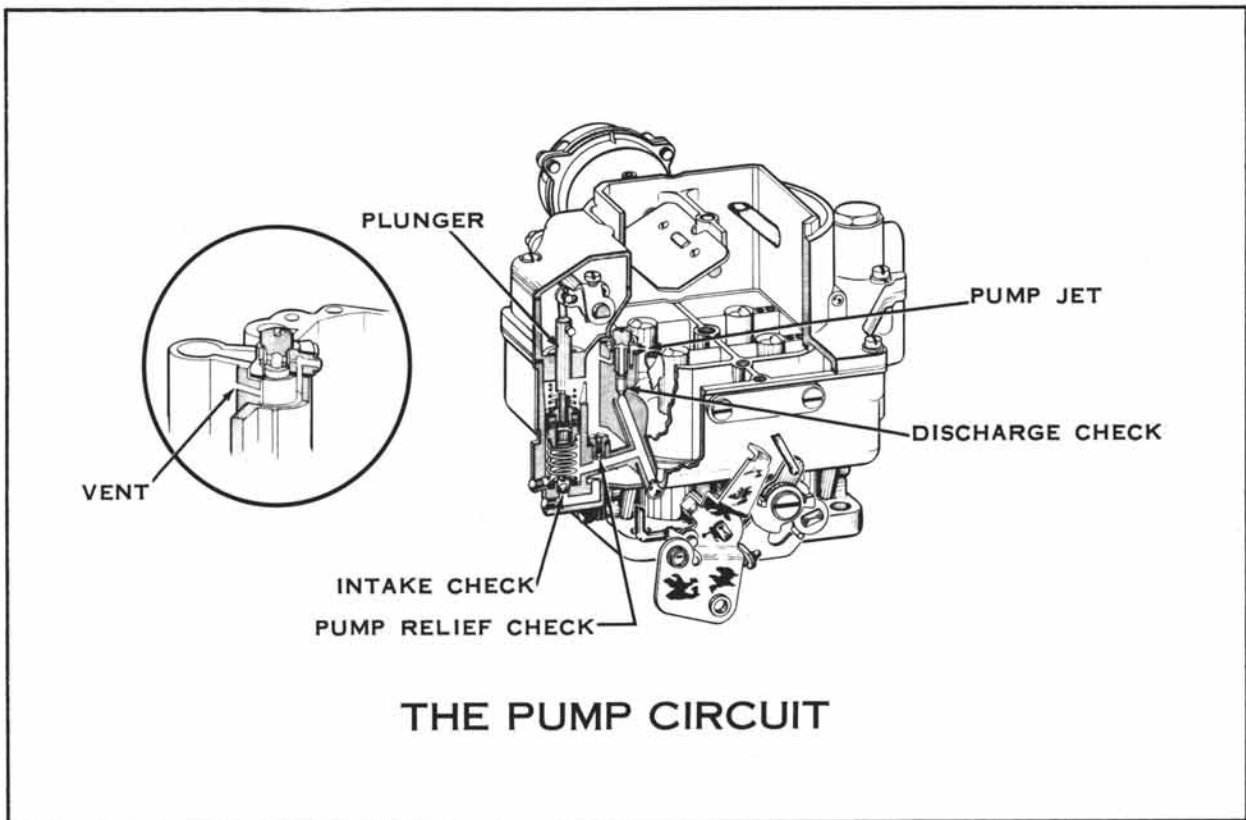

## PUMP CIRCUIT

The pump circuit is found only in the primary side of the carburetor.

The accelerating pump circuit provides a measured amount of fuel, which is necessary to insure smooth engine operation for acceleration at speeds below approximately 30 MPH.

When the throttle is closed, the pump plunger moves upward in its cylinder and fuel is drawn into pump cylinder through the intake check. The discharge check is seated at this time to prevent air being drawn into the cylinder. When the throttle is opened the pump plunger moves downward forcing fuel out through the discharge passage, past the discharge check, and out of the pump jets. When the plunger moves downward the intake check is closed preventing fuel from being forced back into the bowl.

If the throttle is opened suddenly, the upper pump spring will be com-

pressed by the plunger shaft telescoping, resulting in a smoother pump discharge of longer duration.

At speeds above approximately 30 MPH, pump discharge is no longer necessary to insure smooth acceleration. When the throttle valves are opened, a pre-determined amount, the pump plunger bottoms in the pump cylinder eliminating pump discharge due to pump plunger movement at high speeds.

During high speed operation a vacuum exists at the pump jets. To prevent fuel from being drawn through the pump circuit, the passage to the pump jets is vented by a cross passage to the carburetor bowl above the fuel level. This allows air instead of fuel to be drawn off the pump jets.

On certain models a pump relief check prevents excessive pressure in the discharge passage during acceleration.

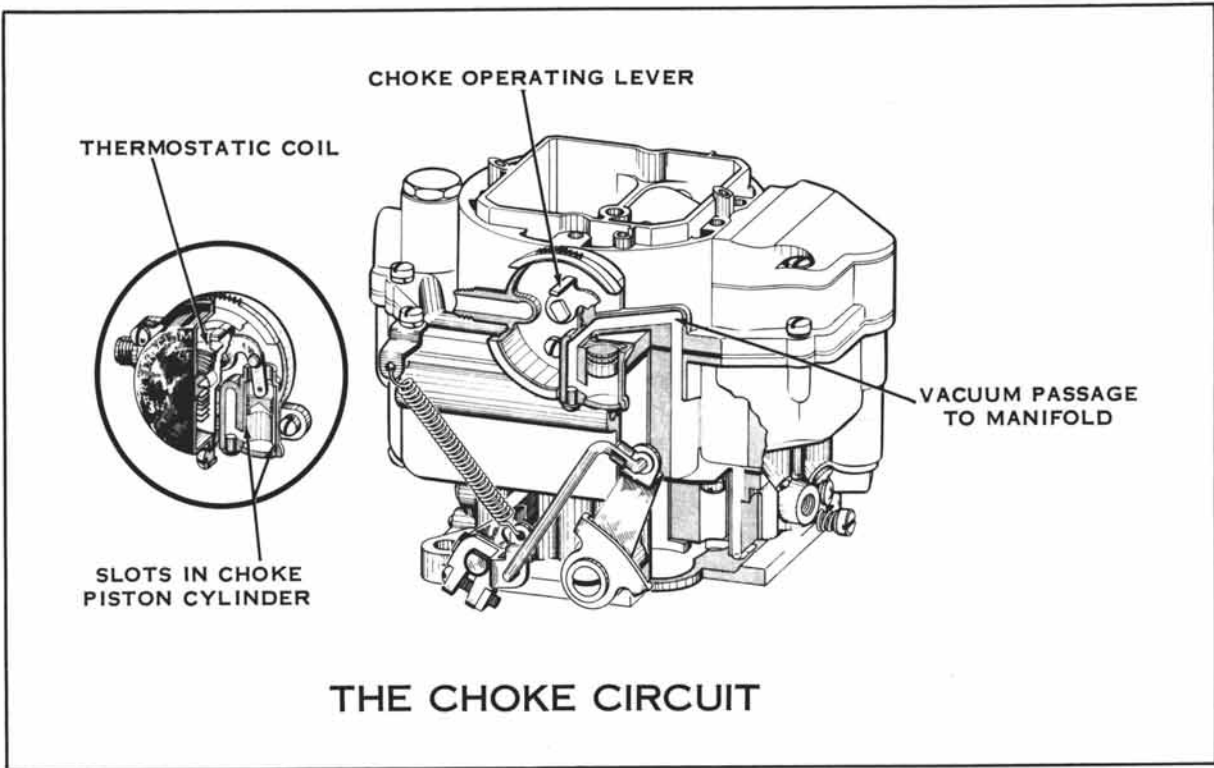

THE CHOKE CIRCUIT

CLIMATIC CONTROL (CHOKE) CIRCUIT

The climatic control circuit provides a rich mixture necessary for quick cold engine starting and warm-up.

When the engine is cold, tension of the thermostatic coil spring holds the choke valve closed. When the engine is started, air velocity against the offset choke valve causes the valve to open slightly against the thermostatic spring tension. Intake manifold vacuum applied to the choke piston also tends to pull the choke valve open. The choke valve assumes a position where tension of the thermostatic spring is balanced by the pull of vacuum on the piston and force of air velocity on the offset valve.

When the engine starts, slots located in the sides of the choke piston cylinder are uncovered allowing intake manifold vacuum to draw warm air from the hot air tube, located in the exhaust manifold, through the climatic control housing. The flow of warm air in turn heats the thermostatic spring and causes it to lose some of its tension. The thermostatic spring loses its tension gradually until the choke valve reaches full open position.

If the engine is accelerated during the warm-up period, the corresponding drop in manifold vacuum allows the thermostatic spring to momentarily close the choke, providing a richer mixture. On certain models a choke modifying linkage between the thermostatic spring and throttle shaft limits choking action during cold engine accelerations.

During the warm-up period it is necessary to provide a fast idle speed to prevent engine stalling. This is accomplished by a fast idle cam which is rotated by a connector rod attached to the choke shaft. The fast idle cam prevents the primary throttle valves from returning to a normal warm engine idle position while the climatic control is in operation.

If, during the starting period, the engine is flooded it is necessary to hold the choke open sufficiently to allow the engine to clean out the excessive fuel in the intake manifold. This may be accomplished by depressing the accelerator pedal to the floor mat and engaging the starter.

The projection on the throttle lever (unloader) will rotate the fast idle cam and in turn partially open the choke valve.

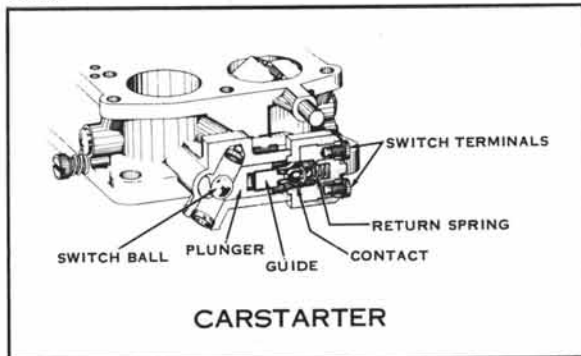

CARSTARTER

STARTER SWITCH  
(certain models only)

The Carter Car Starter Switch operates the solenoid controlling the starting motor.

To start the engine, the accelerator is depressed opening the throttle. The switch ball resting in a notch in the throttle shaft is forced against the plunger. The plunger moves the bakelite guide and switch contact outward until an electrical connection is made between the switch terminals. This completes the starting motor circuit.

When the engine is started and the accelerator released, manifold vacuum pulls the switch ball away from the throttle shaft and upward onto its seat. The switch return spring pushes the contact back interrupting the flow of current to the starting motor. The ball is held up on its seat by manifold vacuum during engine operation. When the engine is stopped, the switch ball drops down into the engaging or starting position.